

S12E

User Manual



HEARTWAY





Manufacturer: Electrically powered scooter Class A (EN 12184) 

Heartway Medical Products. Co. Ltd. No 18th Jingke Central 1st Road Nantun Dist. Taichung City 408, Taiwan ROC.



The users need to consult the instructions of the device for information on how to use it properly

Electrically powered scooter Class C (EN 12184)

Moving of adult disabled persons by self driving.

Maximum user weight: 350 lbs; Classified in Class C (EN12184) ; Maximum safe slope: 10°

The product is not intended for visually impaired people. The drivers need to mentally and physically suitable to drive the scooters. The fingers need to work functionally. The device can't be used by children until age of 12.

The driving distance will be reduced if the power scooter is used frequently on slopes, rough ground or to climb curbs.
The scooter is not for use as a seat in motor vehicle.



All adjustments can be adjusted by either occupant or assistant. This vehicle is suitable for land and/or air transport.

Please refer to our official website for general product information at

www.evrider.com



WARNING

- ⇒ This mobility (scooter) may come to a sudden stop at anytime during the operation
- ⇒ Don't operate your power scooter without completely reading and understanding this user manual!
- ⇒ The overall length of this power scooter exceeds the limits specified Annex M of the technical specifications for interoperability relating to accessibility for persons with reduced mobility
- ⇒ The stopping distance on slopes can be significantly greater than on level ground
- ⇒ Do not operate the scooter with depleted batteries, since the occupant could be stranded.
- ⇒ The end user is NOT allowed to change the parameter.
- ⇒ The occupant can switch off the key to stop the scooter for any emergency stop
- ⇒ Please remove the battery package from the scooter unit before long term storage

S12E should be turned off prior to entering or exiting the seat. Make sure the scooter is fully un-folded before driving.

Please refer to our official website for general product information at www.evrider.com

Environmental conditions may affect the safety and performance of your power scooter. Water and extreme temperatures are the main elements that can cause damage and affect performance.

A) Rain, Sleet and Snow

If exposed to water, your power scooter is susceptible to damage to electronic or mechanical components. Water can cause electronic malfunction or promote premature corrosion of electrical components and frame.

B) Temperature

Some of the parts of the power scooter are susceptible to change in temperature. The controller can only operate in temperature that range between -4 F and 113 F

At extreme low temperatures, the batteries may freeze, and your power scooter may not be able to operate. In extreme high temperatures, it may operate at slower speeds due to a safety feature of the controller that prevents damage to the motors and other electrical components.



SAFETY SYMBOL

The following symbols are used in the scooter to identify warnings, mandatory actions and prohibited actions. It is very important that you read and understand them completely.



Read and follow the information in the instruction manual.



Caution. Observing notes and accompanying documents

Scooter Class C

It is classified in category C according to EN 12184. Outdoor use



For ambient conditions



Protection class II



Charger IPX0 "Protect from moisture" / Scooter IPX4 "Splashproof"



Does not meet the ISO 7176-19 standard and cannot be used as a seat in a motor vehicle.
Labeling on the product.

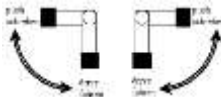

Devices for decommissioning the drive system
Warning: Switch on the drive system again before leaving a user unattended.



Charge the batteries fully before use. Remove the key from an unattended scooter.



Year of manufacture see label on the product.



Heartway Medical Products Co., Ltd.
No.18, Jingke Central 1st Rd., Nantun Dist.
Taichung City 40852, Taiwan (R.O.C.)

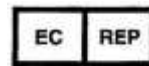

Europäischer Bevollmächtigter / Authorized Representative
Emergo Europe Prinsessegracht 20 2514 AP The Hague
The Netherlands Tel: (31) (0) 70 345-8570
Fax: (31) (0) 70 346-7299

INDICATIONS

Inability to walk or severe walking disability due to

- paralysis
- Loss of limbs
- extremity defect / deformity
- joint
- joint damage (not on both arms)
- other diseases

A supply with a scooter (or also electric wheelchairs) is indicated when the use of hand-driven wheelchairs is no longer possible due to the disability, but the correct operation of an electric motor drive is still possible.

CONTRAINDICATIONS

The supply of scooters is unsuitable for people:

- with severe balance problems
- with reduced and insufficient eyesight
- with severe cognitive impairments

CONFORMITY

This mobility meets the requirements of EN 12184: 2014 and the requirements for class I medical devices in accordance with Class I of Regulation MDR 2017/745 annex VIII.

SAFETY INSTRUCTION

◆ General



Always use a seat belt and keep your feet on the scooter all the time.



Never operate the scooter while you are under the influence of alcohol.



Never use electronic radio transmitters such as walkie-talkies, or cellular phones.



Make sure that there are no obstacles behind you while reserving your scooter.



Do not make a sharp turn or a sudden stop while riding your scooter.



Do not rider your scooter in traffic.



Do not attempt to climb curbs greater than limitation show on Technical Specification.



Do not leave your hands and legs off the scooter when driving.



Do not rider your scooter during snow in order to avoid accident on slippery road.



Do not allow unsupervised children to play near this equipment while the batteries are charging.



WARNING

1. Don't operate scooter on public streets and roadways. Be aware that it may be difficult for traffic to see you when you are seated on the scooter. Obey all local pedestrian traffic rules. Wait until your path is clear of traffic, and then proceed with extreme cautions.
2. To prevent injury to yourself or others, always ensure that the power is switched off when getting on or off the scooter.
3. Always check that the drive wheels are engaged (drive mode) before driving. Do not switch off the power when the scooter is still moving forward. This will bring the chair to an extremely abrupt stop.
4. Do not use this product or any available optional equipment without first completely reading and understanding these instructions. If you are unable to understand the warnings, cautions or instructions, contact a healthcare professional, the dealers or technical supports before attempting to use this equipment, otherwise, injury or damage may occur.
5. There are certain situations, including some medical conditions, where the scooter user will need to practice operating the scooter in the presence of a trained attendant. A trained attendant can be defined as a family member or care professional especially trained in assisting a scooter user in various daily living activities. Consult with your physician if you are taking any medication that may affect your ability to operate your scooter safely.
6. Do not attempt to lift or move a power scooter by any of its removable parts including the armrests, seats or shrouds. Personal injury and damage to the power chair may result.
7. Never try to use your scooter beyond its limitations as described in this manual.
8. Please do not sit on your scooter while it is in a moving vehicle.
9. Keep your hands away from the wheels (tires) while driving scooters. Be aware that loose fitting clothing can become caught in the drive tires.
10. Consult your physician if you are taking prescribed medication or if you have any certain physical limitations. Some medications and limitations may impair your ability to operate scooters in a safe manner.
11. Be aware when the drive mode is unlocked or locked.
12. Don't remove anti-tipper if there is any-tipper equipped with the scooter.
13. Contact with tools can cause electrical shock and do not connect an extension cord to the AC/DC converter or the battery charger.
14. Do not attempt to lift or move your scooter by any of its removal parts, such as the armrests, seats, or shroud.
15. When climbing an incline, don't drive at an angle up the face of the incline. Drive your scooter straight up the incline. This greatly reduces the possibility of a tip or a fall.
16. Don't climb a slope steeper than the scooter's limitation.
17. Don't attempt to have your scooter proceed backward down any step, curb or other obstacle. This may cause the scooter to fall or tip.
18. Always reduce your speed and maintain a stable center of gravity when cornering sharply. Don't corner sharply when driving scooters at higher speeds.

19. Operating in rain, snow, salt, mist conditions and on icy or slippery surfaces may have an adverse affect on the electrical system.
20. Never sit on your scooter when it is being used in connection with any type of lift or elevation product. Your scooter is not designed with such use in mind and any damage or injury incurred from such use is not the responsibility of Heartway.
21. Don't touch the motor after driving. It is hot.
22. Drive-wheel needs to be switched to engaged-mode while transporting the power scooter with a car or airplane.
23. Drive-wheel needs to be switched to engaged-mode while transporting the power scooter with a car or airplane.
24. Surface temperatures can increase when exposed to external sources of heat.
25. Surfaces of the power scooter that can come into direct contact with the occupant's skin and during normal use and that are within occupant reach shall not exceed 105 °F. The motor surface can reach temperatures greater than 105°F after driving. Do not touch these parts when disassembling the scooter or wait until the motor is cooled down.
26. Please always turn off the power prior to entering or existing this scooter.
27. Do not operate this scoter if it is behaving abnormally or erratically.

MODIFICATIONS

Heartway Medical Product has designed and engineered power scooter to provide maximum utility. However, under no circumstances should you modify, add, remove, or disable any part or function of your power scooter. Personal injury and damage to the power scooter may result.

1. Do not modify your power scooter in any way not authorized by Heartway. Do not use accessories if they have not been tested or approved for Heartway products. Changing of controller parameter shall be only performed by authorized technicians due to the safety concern.
2. Get to know the feel of your power scooter and its capabilities. Heartway recommends that you perform a safety check before each use to make sure your power scooter operates safely.

◆ Inspections prior to using your power scooter:

1. If equipped with pneumatic tires, please check for proper tire inflations.
2. Please check all electrical connections and make sure they are tight and not corroded.
3. Please check all harness connections and make sure they are secured properly.
4. Please check the brakes.

◆ Weight limitation.

1. Please refer to the specifications table for weight capacity information. Power scooter is rated for a maximum weight capacity.
2. Stay within the specified weight capacity for your scooter. Exceeding the weight capacity voids your warranty.

Heartway will not be held responsible for injuries or property damage resulting from failure to observe weight limitations.

3. Don't carry passengers on scooters.
4. Carrying passengers on scooter may affect the center of gravity, resulting in a tip or a fall.

◆ Tire inflation

1. If your scooter is equipped with pneumatic tires, it is necessary to check the air pressure at least one time a week.
2. Proper inflation pressures will prolong the life your tires and ensure the smooth operation while riding.
3. Do not under-inflate or over-inflate your tires. It is critically important that 30-35 psi (2-2.4 bar) tire pressure be maintained in pneumatic tires at all times.
4. Inflating your tires from an unregulated air source could over-inflate them, resulting in a burs tire.

◆ Temperature



1. Some of the parts of the power scooter are susceptible to change in temperature. The controller can only operate in temperature that ranges between -4°F ~ 113°F .
2. At extreme low temperatures, the batteries may freeze, and your power scooter may not be able to operate. In extreme high temperatures, it may operate at slower speeds due to a safety feature of the controller that prevents damage to the motors and other electrical components.
3. The scooter can generally be operated at outside **temperatures from -4°F to 113°F .**
4. Some parts of the scooter tend to be temperature dependent. The controller works best at temperatures between **77°F and 122°F .**
5. **Below -5°F the batteries can freeze and the scooter may not work.**
6. At extremely high temperatures **$> 113^{\circ}\text{C}$** , the safety function of the control, which prevents damage to the motors and other electrical components, can lead to slower maximum speeds.

ELECTROMAGNETIC INTERFERENCE (EMI)

The rapid development of electronics, especially in the area of communications, has saturated our environment with electromagnetic (EM) radio waves that are emitted by television, radio and communication signals. These EM waves are invisible, and their strength increases as one approaches the source. All electrical conductors act as antennas to the EM signals and, to varying degrees, all power scooters and scooters are susceptible to electromagnetic interference (EMI). The interference could result in abnormal, unintentional movement and/or erratic control of the vehicle. The United States Food and Drug Administration (FDA) suggests that the following statement be incorporated to the user's manual for all power scooter like the **S26**. Power scooters may be as susceptible to electromagnetic interference (EMI), which is interfering electromagnetic energy emitted from sources such as radio stations, TV stations, amateur radio (HAM) transmitter, two-way radios, cellular phones and alarm systems of shops. The interference (from radio wave sources) can cause the power scooter to release its brakes, move by itself or move in unintended directions. It can also permanently damage the powered scooter's control system. The intensity of the EM energy can be measured in volts per meter (V/m). Each powered scooter can resist EMI up to a certain intensity. This is called "immunity level". The higher the immunity level the greater the protection. At this time, current technology is capable of providing at least 20 V/m of immunity level, which would provide useful protection against common sources of radiated EMI.

Following the warnings listed below should reduce the chance of unintended brake release or powered scooter movement that could result in serious injury:

1. Do not turn on hand-held personal communication devices such as citizens band (CB) radios and cellular phones while the powered scooter is turned on.
2. Be aware of nearby transmitters such as radio or TV stations and try to avoid coming close to them.
3. If unintended movement or brake release occurs, turn the powered scooter off as soon as it is safe.
4. Be aware that adding accessories or components, or modifying the powered scooter, may make it more susceptible to interference from radio wave sources
(Note: It is difficult to evaluate the effect on the overall immunity of the powered scooter).
5. Report all incidents of unintended movement or brake release to the powered scooter manufacturer and note whether there is a radio wave source nearby.

TURN OFF YOUR POWERED SCOOTER AS SOON AS POSSIBLE WHEN EXPERIENCING THE FOLLOWING:

- Unintentional scooter movements.
- Unintended or uncontrollable direction.
- Unexpected brake release.

The FDA has written to the manufacturers of power scooters asking them to test new products to be sure they provide a reasonable degree of immunity against EMI. The FDA requires that a powered scooter should have an immunity level at least 20 V/m, which provides a reasonable degree of protection against more common sources of EMI. The higher the immunity level the greater the protection. Your powered scooter has an immunity level of 20 V/m which should protect against common sources of EMI.



- The scooter itself can disturb the performance of the electromagnetic fields such as emitted by alarm systems of shops.

PRODUCT SPECIFICATION

MODEL	S12E
WEIGHT CAPACITY	350 lbs
SEAT: TYPE/SIZE	20" Seat
DRIVE WHEEL	12.3"x4"
FRONT CASTER (WHEEL)	12.3"x4"
REAR CASTER (ANTI-TIPPER)	2.4"x0.7"
MAX SPEED	7.5 MPH
BATTERY SPECIFICATIONS	80 AH X 2
BATTERY RANGE	Up to 28 miles
CHARGER TYPE	5 AMP Charger
CONTROLLER TYPE	Rhino2- 120A
MOTOR TYPE	750 W, 4-Pole Motor
WEIGHT: W/ BATTERY	258 pounds
WEIGHT: W/O BATTERY	192 pounds
TURNING RADIUS	49"
SUSPENSION	FULL
LENGTH	54"
WIDTH	26"
HEIGHT	53"
SEAT WIDTH	20"
SEAT HEIGHT	20"
SEAT DEPTH	20"
BACK HEIGHT	21"
WHEELBASE	39"
Maximum Recommended Safe Slope	10 Degree
GROUND CLEARANCE	3"

The scooter seat is tested according to EN1021 regarding resistance to ignition, but it is recommended to avoid users of flame near the scooters and smoking during sitting on the scooter.

Seat belt is regarded as a standard device for this power scooter

Indication/ Intended Purpose:

Moving of disabled persons by self-driving. This medical equipment is intended to provide mobility to persons restricted to a seated position, e.g. for patient recovery, especially for the leg disabled person.

TECHNICAL SPECIFICATION (ISO 7176-15)

13.1 TABLE: Information disclosed in manufacturer's specification sheet

	Min.	Max.		Min.	Max.
Static stability downhill	15°	–	Seat plane angle	5°	
Static stability uphill	15°	–	Seat surfact height at front edge	26"	27"
Static stability sideways	15°	–	Backrest angle	90°-135°	
Dynamic stability uphill	10°	–	Armrest to seat distance	Open construction	
Minimum braking distance from max speed	8.5 feet	–	Horizontal location of axle	.80"	







BASIC OPERATION OF SCOOTER

The power scooter is simple to operate. However we recommend that you read carefully the following instructions to become familiarized with your new vehicle.

Caution:

Before you turn the power on, always be aware of the environment that surrounds you to select your desired speed. For indoor environments we recommend that you select the slowest speed setting. For outdoor operation of this vehicle we recommend that you select a speed that is comfortable for you to control it safely. The following steps are required to operate your vehicle safely with the controller



	Battery indicator
	Manual speed adjuster
	Head-Light Switch
	Hazard Lights Switch
	Left Signal Lights Switch
	Right Signal Lights Switch
	Horn button

Button functions

1. Battery Indicator: Battery remaining capacity and charging indicator (10 squares + Battery Icon)
2. Manual Speed Adjuster: This allows you to pre-select your desired speed. The adjuster is proportional to speed and can be set anywhere between green for low speed to red for high speed. Turn the adjuster knob counter-clockwise to minimum for a very gentle operation, and clockwise towards maximum to increase your speed.
3. Power ON/OFF Light: The light will turn on if you insert into the key. The light will turn off if you take out of the key.
4. Headlight Switch Button: Press once to turn on the headlight. Press again to turn the headlight off.
5. Hazard Lights Switch Button: Press once to turn hazard lights on, both right / left front and back signal lights will flash once per second, and horn will beep once per second, press again to turn hazard lights off.
6. Left Signal Lights Switch Button: Press once to turn left signal lights on. (Both left front and back signal lights will flash once per second, horn will beep once per second, press again to turn left signal lights off.)
7. Right Signal Lights Switch Button: Press once to turn right signal lights on. (Both right front and back signal lights will flash once per second, horn will beep once per second, press again to turn right signal light off.)
8. Horn button: Press this button to sound the horn.(Easy operation for left hand or right hand)

Driving: Controller ON/OFF Switch

Insert the key to turn the scooter power on (Turn the power off and remove the key). Push the finger lever control forward or backward to control the driving direction of the vehicle.

Returning of the finger lever control to its neutral position(center), will reduce the speed and stop the vehicle by automatically applying the electromagnetic brakes.







Speed Control:

- Turn the speed adjuster knob clockwise towards maximum to increase your speed, and counter-clockwise toward minimum to slow down your speed.
- Wig-wag Controlling.

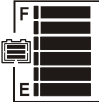
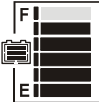
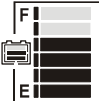
The wig wag lever control also controls the speed of your vehicle. The further away (forward/ backward) the finger lever control is from the neutral position, the faster the vehicle will go.

Notes: In case of emergency, let go of the finger lever control and the vehicle will come to a stop.



ITEM	SPECIFICATION		
Battery Remaining Capacity	Remaining Capacity (%)	Voltage (V)	Scale Bar
	100 (6)	> 25.42	
	85 (5)	≤ 25.42	
	70 (4)	≤ 25.12	
	55 (3)	≤ 24.78	
	40 (2)	≤ 24.42	
	30 (1)	≤ 23.88	 and  Flashing
	20	Low-power Warning	 Warning LED Flashing

- Please release the throttle lever and then allow your scooter to come to a complete stop.

- The automatic brake will become activated if the transferring speed is more than 30% of the maximum speed while the scooter is driving down-slope at free-wheel mode.

ENGAGED



DISENGAGED (FREE WHEEL)

 **WARNING**

- ✧ Please be noted that the scooter will be at free-wheel mode, when the motor is disengaged.
- ✧ To use the parking brake, you must move and lock the lever into the engaged position!
- ✧ When your power scooter is in freewheel mode, the braking system is disengaged!
- ✧ Use the freewheel mode only with an assistant! The assistant may operate the engaging lever to apply the parking brake.

Tiller Positioning

- Press down the lever and adjust it into your preferred position.
- Never attempt to adjust the tiller while the scooter is in motion.
- Make sure the tiller is at a comfortable setting and located securely.

Adjustment for Seat Comfort

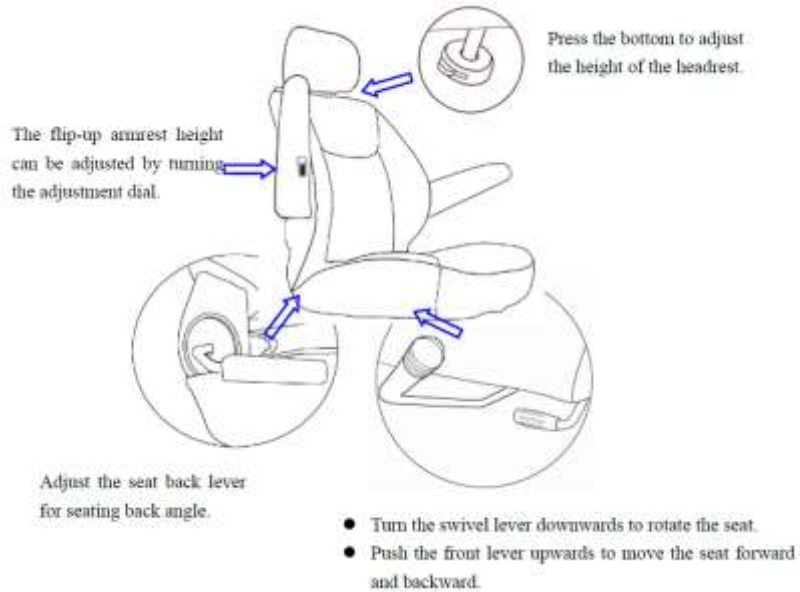

WARNING

The temperature of scooter surface can increase when the scooter is exposed to external source of heat (e.g. sunlight)
For any mechanical adjustment on the tiller or on the seat, be aware of trapping and squeezing of your fingers.

How to remove the seat

Please refer to the following instructions.

- 1) Press the swivel lever
- 2) Swivel the seat
- 3) Pull the seat upward (Two persons are required to remove the seat)
- 4) Removing the battery and seat from the scooter is allowed before transporting.

Storage

- Your power scooter should be stored in a dry place, free from temperature extremes. When storing, disconnect the batteries from the power scooter. If you fail to store the unit properly, the frame can rust, and the electronics can be damaged.
- Please remove the battery package from the scooter unit before long term storage
- Batteries that are regularly and deeply discharged, infrequently charged, stored in extreme temperatures, or stored without a full charge may be permanently damaged, causing unreliable performance and limited service life. It is recommended that you charge the batteries periodically throughout periods of prolonged storage to ensure proper performance. You may wish to place several boards under the frame of your power scooter to raise it off of the ground during periods of prolonged storage.

If you plan on not using your power scooter for an extended period of time, it is best to:

- ⇒ Fully charge its batteries prior to storage.
- ⇒ Disconnect the batteries from the scooter.
- ⇒ Store your power scooter in a warm, dry environment.
- ⇒ Avoid storing your power scooter where it will be exposed to temperature extremes.
- ⇒ Controller operating conditions (-4 F ~113 F) and controller storage conditions (-4. F~149F)
- ⇒ Controller operating humidity range Min 0% RH ~ 90% RH
- ⇒ Make sure the batteries are fully charged before use after long-term storage

Batteries that are regularly and deeply discharged, infrequently charged, stored in extreme temperatures, or stored without a full charge may be permanently damaged, causing unreliable performance and limited service life. It is recommended that you charge the power scooter batteries periodically throughout periods of prolonged storage to ensure proper performance.

CHARGING INSTRUCTION

Battery Charger Instruction

5A

1. Appearance

1. LED INDICATOR (CHARGE)
2. LED INDICATOR (POWER)
3. POWER SOCKET
4. (115V/230V) INPUT VOLTAGE ADJUSTER
5. OUTPUT PLUG TO BATTERY

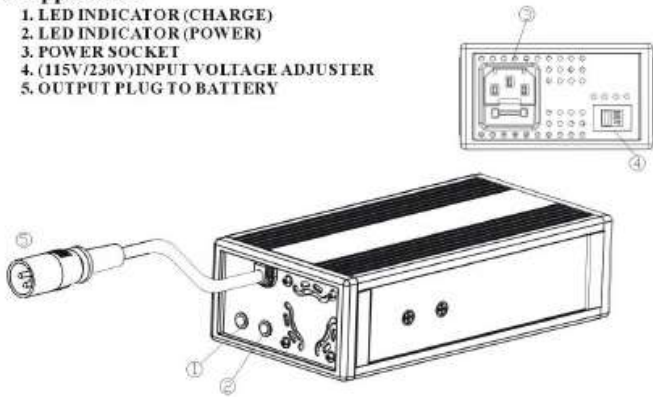

2. SPECIFICATION

Item	BATTERY CHARGER (SWITCHING MODE)
Model	4C24050A
Output Current(DC)	5A
Charging Voltage(DC)	28.8V
Floating Voltage(DC)	27.6V
Input Current (AC)	4/2 A
Input Voltage(AC)	115 Vac Or 230 Vac 50/60 Hz (Manual Select)
Efficiency	AC-DC 80% min
Operating Temperature	0°C ~ 40°C
Performance	Switching Mode
Charging Method	Constant current two stage constant voltage
Battery Application	24V Lead Acid Rechargeable Battery (20Ahr ~ 60Ahr)
Output Detection	<ol style="list-style-type: none"> 1. Short Circuit Protection 2. Output Voltage/ Current Limit 3. Reverse Power Protection 4. Overheat Detection
Operating Temperature	0~ 40 Degree (Celsius)
Measure	L 190mm×W 100mm×H 55mm
Weight	965g
Color	Black

3. OPERATING INSTRUCTION

- (1) Make sure the battery charger output voltage is the same as the connecting battery.
- (2) Plug in the power cord. LED indicates green flash when AC power on.
- (3) Connect the battery charger to the battery.
- (4) Start charging; please refer to 4. LED INDICATION

4. LED INDICATION

- (1) Green Flash : Power on
- (2) Orange : Charging
- (3) Orange Flash : Pre charge
- (4) Green & Orange Flash : Charged 80% ◦
- (5) Green : Full charged (Floating charge) ◦
- (6) Red: Error / Abnormal temperature

- Red indication keeps flashing: $1V < \text{Battery voltage} < 9V$
- Red indication keeps flashing X 2: a) Wrong connection b) Short circuit c) VBAT $< 16V$
- Red indication keeps flashing X 3: a) VBAT $> 28.8V$ (can't charge the battery) b) Battery and Jimmy are defective
- Red indication keeps flashing X4: a) Charging system defective b) Battery defective partially
- Red indication keeps flashing X5: a) Charging hours exceeds 24 hours
- Red indication keeps flashing X6: a) Battery voltage $< 16V$ (12V Battery)
- Red indication keeps flashing X7: a) Abnormal temperature occurs during battery charging

5. TROUBLE SHOOTING

- (1) If green indicator is off :
Check AC input. If it works functionally, the battery charger may be defective.
- (2) If green indicator keeps flashing and cannot turn to charging indication :
Check if the battery connector is connected successfully.
Check if there is any short circuit on the output connection.
The battery charger may be defective if the battery connection works functionally.

- (3) If red indicator keeps flashing :
Check if the battery connection is reversed.
Check if there is any short circuit on the output connection.
Check if the environment temperature is too low (0°C)
The battery charger may be defective if the red indicator continues to flash.
- (4) Charging indicator (orange) cannot turn to green :
The battery might be defective, please stop charging and have the battery be repaired.
- (5) If the charging indicator (orange) turns to green (fully charged) immediately :
The battery may be in well-charged condition.
The battery may be defective if the battery is not fully charged.



Warning! The charger should only be used in a dry interior. Protect from moisture and wetness.



Forbidden! Although the travel scooter has passed the required IPX4 water spray test requirements, keep electrical connections away from sources of moisture, including direct exposure to water or body fluids, and incontinence. Check the electrical components frequently for signs of corrosion and replace if necessary.

6. CAUTION

- (1) Before using the battery charger, read all instructions and cautionary markings.
- (2) Use the battery charger in a well-ventilated area
- (3) To avoid the risk of injury, charge only lead-acid or gel cell type rechargeable batteries.
- (4) Please turn off the power after charging
- (5) **Plug the off-board charger power cord into the charger port during battery charging.**



Off-Board Charger Port
The off-board charger port is mounted on the tiller.

Note: Only use the battery charger which was provided by the scooter supplier. The use of any different type of charger can be hazardous and need the approval of the manufacturer.

WARNING

- ❖ Always charge your batteries in well ventilated areas.
- ❖ The charger is intended for indoor use only. Please protect it from the moisture.
- ❖ For maximum performance, it is recommended that you replace both batteries at the same time if the batteries are weak.
- ❖ If the scooter will not be used for a long period of time, arrange to have the batteries recharge at least once every month to avoid deterioration of the batteries.
- ❖ **Can we use a different charger? Please understand that chargers are selected specifically for particular applications and matched to the type and size of specific batteries. In order to charge your scooters safely and efficiently, we recommend use of the charger supplied as original equipment with your Heartway product only. Any charging method resulting in batteries being charged individually is prohibited.**



BATTERY INSTRUCTION & MAINTENANCE

Safety Precautions for Lead Acid Batteries

Danger!! Failure to follow these precautions may result in serious risk.

- Read through the charger operating instruction before using it.
- If you use your scooter every day, please charge its batteries as soon as you finish using it for the day. Your scooter will be ready each morning.
- Avoid deeply discharging your scooter's batteries.
- Charge the battery at least 24 hours a week if the power chair or scooter has not been used.
(This is to make sure that the electrolyte is always at the top level)
- If the battery cannot be charged (Orange light cannot turn to Green) or if the Orange light turns to Green immediately, please check it with the technicians. The battery may be defective.
- The voltage difference between the two batteries on a power unit cannot be more than 0.5 V; the battery case should be inspected for cleanliness and evidence of damage.
- If the charger indicates red light, please kindly check if the charger is defected or if the cable wiring connection is poor.
- Please keep the battery ⊖ and ⊕ connectors clean otherwise the charging condition will be poor.
- When installing batteries, please do not use sealed containers. Use of sealed containers may cause explosions, fires, injury, or equipment damage.
- Do not place batteries in enclosed environments or near open flames. Batteries may produce hydrogen which can cause explosions or fires.
- Do not use metal wires to connect batteries and prevent tools from making short circuit between batteries terminals. This can cause fire or cause the battery to leak acid, overheat, or explode.
- Do not transport or store batteries together with tools or metal wire. This can cause fire or cause the battery to leak acid, overheat, or explode.
- Charge batteries using specified chargers or as directed by the manufacturer. Charging batteries by any other methods can lead to overheating, excessive hydrogen leaks, acid leaks, or explosions.
- Pliers, torque wrenches and other metal tools should be insulated with PVC tape before use. Failure to do so could cause short circuits which could lead to sparking or high temperature which could cause fire, damage or explosions of the battery.

- Ensure that short circuits is not formed between the positive and negative terminals. Short circuits may lead to leaks, fires, or explosions.
- Do not use these batteries together with different type of the batteries such as Ni-MH or Ni-Cd and so on. It could lead to leaks, overheating, or explosions of the batteries, and human injury.
- If the battery catches on fire, please use dry powder fire extinguisher or carbon dioxide fire extinguisher. Do not use water to fire fighting.
- Do not expose batteries to heat or flames. This can cause leakage, fire, or explosion of the batteries.
- Do not dismantle, modify, or damage batteries. This can cause leakage, fire, or explosion of batteries.
- Replace batteries within the period recommended in battery user manual or indicated on the equipment. Overuse may cause internal short circuits or battery case damage which can lead to leakage, fire, or explosion of the batteries.
- When installing batteries, ensure that positive and negative polarity is correct. Connection with incorrect polarity can lead to excess current, fire, and damage to chargers.
- Batteries contain dilute sulfuric acid. Any acid leaked from damaged batteries should be immediately rinsed from clothing or skin. If acid comes in contact with eyes, rinse with a large quantity of water and seek medical attention immediately. Acid can burn skin and can cause blindness.
- Batteries showing signs of terminal corrosion, leakage, distortion of battery case, or any other abnormalities should not be used. Continued use could result in leakage, fire, or explosion of the batteries.
- Do not use or store batteries near transformers or other heat sources, inside of the car left outside, in direct sunlight, or in other high temperature environments. Doing so can lead to increased battery temperature, which can cause leakage, fire, or explosion.

When installing batteries in metal enclosures, fill the space between the battery and enclosure with acid resistant, heat resistant insulating materials, to avoid contact between the battery and the enclosure. Batteries with acid leakage can create smoke and flames.

- When handling batteries wear rubber gloves and rubber shoes. Failure to do so can lead to electric shock, burns, or fire.
- Do not place batteries where they might be exposed to water as an electric leak may cause electric shock, or fire.
- Do not position batteries at more than 90° from the upright position as this can lead to leakage, fire, or explosion.
- Do not clean batteries with dry cloths or feather dusters as this can produce static electricity and cause explosions. Use damp cloths only.
- Attach all required insulator caps to battery terminals and link as specified. Failure to do so may result in electric shock, burns, short circuit, battery damage, fire, or explosion.
- When used in medical equipment, it should be equipped with not only this battery systems but another different backup system. Failure to do so could lead to injury in the event of this battery system failure.
- Do not directly connect batteries to power outlets or automobile cigarette lighter socket. This can lead to burns or overheating.

- Use batteries in the following temperature range. Discharge (equipment in use): 5F~122F; Charge: 32F~104F; Storage: 5F~104F.
- Do not apply thinner, gasoline, benzine, lubricants, fats, or any other organic solvents or detergents. This may lead to the crack of the battery case, leakage, and fire.
- Batteries should be checked regularly. Batteries not conforming to specifications listed in the user's manual should be adjusted following user's manual. Continued use without adjustment could lead to damage or burns.
- Used batteries can be recycled. Do not dispose of directly without consulting sales company or our agents.
- When cleaning and inspecting batteries, first discharge static electricity from your body. Static electricity can cause sparks which can lead to explosions.
- Batteries' maximum discharge current should not exceed the specifications in the user's manual.
- Excessive discharge current can cause leakage, overheating, and explosion.
- Immediately after purchase, if any rust, cracks, deformities, overheating, or any other abnormality is discovered, discontinue use and contact the sales company. Continued use could result in leakage, overheating, or explosion.
- When using multiple batteries at the same time, the batteries themselves should be properly connected before they are connected to the charger or load. Firmly connect the positive terminal of the battery to the positive terminal of the charger or load. Incorrect polarity can lead to explosions or fires harming the batteries or equipment and can cause injury to humans.
- Do not bump, drop, or strike batteries. Batteries should not be used in environments subject to strong vibration as these can damage the batteries.
- Do not use batteries in dusty environments as this can lead to short circuits (if batteries must be used in dusty environments they should be periodically inspected).
- Do not use batteries from different manufacturers in the same string. Small differences between the batteries can affect operational stability and can significantly reduce battery life and lead to deformation and overheating.
- In case suitable batteries spec for the equipment is not known, consult with the manufacturer prior to use.
- In case of long periods of non-use, disconnect batteries from equipment.
- Batteries are heavy; care should be taken when handling to avoid back injury.
- Battery powered equipment should be separated by the distances specified in manuals or on labels in order to prevent failure. In certain cases the minimum distances are specified by laws.
- Battery powered equipment should be inspected as specified in the user manual; except when inspections are regulated by law. For details please consult the manufacturer.
- Battery powered equipment requires special power distribution cabling set up that should be performed by professionals. In certain countries the work must be done by nationally certified electrical engineers.
- Certain countries have laws covering battery powered equipment that must comply with.
- Do not use batteries except for specified application. Inappropriate use could lead to leakage, fire, or explosion.
- To avoid making leak circuit by the acid leaked from batteries, take preventive measure on the circuit or place an insulating layer or insulating tray between the batteries and the frame.

To Change the batteries in your scooters:

- Remove the battery cover and captain seat.
- Unfasten the battery tie-down strap.
- Disconnect the battery harnesses properly.
- Disconnect the battery by opening two gray main connectors and also three smaller connectors (two white and one red).
- Remove the old batteries from the battery wells.
- Place a new battery in each battery well.
- Reconnect the gray connectors.
- Check the terminal boots for correct position..
- Reconnect the battery tie-down strap.
- Reinstall the battery cover and seat back to the scooter.
- Removing the battery and seat from the scooter is allowed before transporting.
- Please remove connectors (A, B, C, D, E) first before removing the battery.

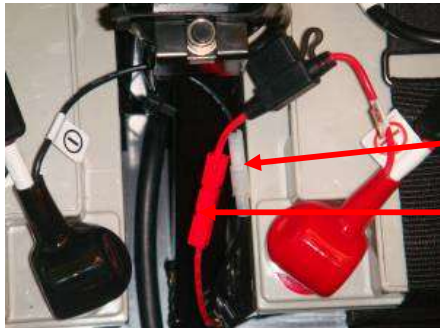

Connector A (White)

Connector B (Red)

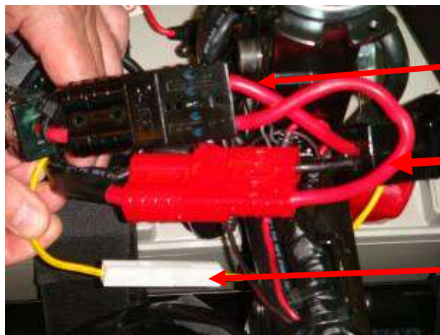

Connector C (Black)

Connector D (Red)





Connector E (White)

WARNING

- ✧ Please remove connectors (A, B, C, D, E) first before removing the battery.
- ✧ If you hand is wet or sweaty, Do NOT replace the batteries.
- ✧ Please always use two batteries of the same type at the same amp-hour capacity.
- ✧ Always replace both batteries at the same time. Please do not mix old and new batteries together.

SCOOTER MAINTENANCE & REPAIR

Your power scooter is designed for minimal maintenance. However, like any motorized vehicle it requires routine maintenance. To keep your power scooters or power wheelchairs for years of trouble-free operation, we recommend you follow the following maintenance checks as scheduled.

Maintenance Job	Daily	Weekly	Monthly	Semi-Annual
Electrical System				
✧ Battery meter – Inspect the battery meter to determine if batteries are needed to be re-charged				
✧ Controller / Display panel – Make sure they are not frayed or have any exposed wiring				
✧ Check all plug & wiring connections for firm condition				
✧ Have the batteries been fully charged before the daily operation				
✧ Are all holder and screws firmly fixed and safe?				

Maintenance Job	Daily	Weekly	Monthly	Semi-Annual
Are all electric lighting system (if applicable) in working order				
✧ Tires & Wheels				
✧ Have pneumatic tyres checked for necessary air pressure				
✧ Front & Rear wheels must be able to spin smoothly without any interference				
✧ Rear & Front wheels must spin without wobbling				
✧ Visually inspect the tire tread. If less than 1 mm (1/32"), please have your tires replaced by your local dealer.				
✧ Others				
Motor brushes. We recommend that your authorized dealer inspect the brushes every six-month if your power scooter or power wheelchair is not operating smoothly. If the inspection determines excessive motor bushes worn out, they must be replaced otherwise the motor damage will result.				

CARE AND MAINTENANCE

Scooters require a minimal amount of care and maintenance. The following areas require inspection and/or care and maintenance.

TIRE PRESSURE

- ⇒ If equipped with pneumatic tires, always maintain the air pressure in psi rating indicated on each tire. Make sure to maintain the pressure of the tires between 30-35 psi (2.0 – 2.4 bar).
- ⇒ It is important that the air pressure in psi rating indicated on each tire be maintained in pneumatic tires at all times. Do not overinflate your tires. Low pressure may result in loss of control, and overinflated tires may burst. Failure to maintain the air pressure in psi rating indicated on the tires at all times may result in tire and/or wheel failure. Regularly inspect your scooter's tires for signs of wear.

CLEANING AND DISINFECTION

- ⇒ Use a damp cloth and mild, non-abrasive cleanser to clean the plastic and metal parts of your scooter. Avoid using products that may scratch the surface of your scooter.
- ⇒ If necessary, clean your product with an approved disinfectant. Make sure the disinfectant is safe for use on your product before application.
- ⇒ Follow all safety instructions for the proper use of the disinfectant and/or cleaning agent before applying it to your product. Failure to comply may result in skin irritation or premature deterioration of upholstery and/or scooter finishes.

BATTERY TERMINAL CONNECTIONS

- ⇒ Make certain that the terminal connections remain tight and uncorroded.
- ⇒ The batteries must sit flat in the battery wells.
- ⇒ The battery terminals should face towards the inside of the scooter.

WIRING HARNESSES

- ⇒ Regularly check all wiring connections.
- ⇒ Regularly check all wiring insulation, including the charger power cord, for wear or damage.
- ⇒ Have your authorized dealer repair or replace any damaged connector, connection, or insulation that you find before using your scooter again.

AXLE BEARINGS AND THE MOTOR/TRANSAXLE ASSEMBLY

These items are all pre-lubricated, sealed, and require no subsequent lubrication.

WHEEL REPLACEMENT

If your scooter is equipped with pneumatic tires and you have a flat tire, you can have the tube replaced. If your scooter is equipped with a solid tire insert either the solid insert or the entire wheel must be replaced depending on the model. Contact your authorized dealer regarding replacement wheels for your scooters.



WARNING

- ⇒ Wheels on your scooter should only be serviced/replaced by a qualified technician.
- ⇒ Completely deflate pneumatic tires before dismantling the rim or attempting repair.
- ⇒ Be sure that the key is removed from the key switch and the scooter is not in free-wheel mode before performing this procedure repair.
- ⇒ When changing a pneumatic tire, remove only the lug nuts, then remove the wheel. If any further disassembly is required, deflate the tire completely or it may explode.

MOTOR BRUSHES

The motor brushes are housed inside of the motor transaxle/assembly. They should be inspected periodically for wear by your authorized dealer.

CONSOLE, CHARGER, AND REAR ELECTRONICS

- ⇒ Keep these areas free of moisture.
- ⇒ Allow these areas to dry thoroughly if they have been exposed to moisture before operating your scooter again.

STORING YOUR SCOOTER

If you plan on not using your scooter for an extended period of time, it is best to:

- ⇒ Fully charge its batteries prior to storage.
- ⇒ Disconnect the batteries from the scooter.
- ⇒ Store your scooter in a warm, dry environment.
- ⇒ Avoid storing your scooter where it will be exposed to temperature extremes.

Batteries that are regularly and deeply discharged, infrequently charged, stored in extreme temperatures, or stored without a full charge may be permanently damaged, causing unreliable performance and limited service life. It is recommended that you charge the scooter batteries periodically throughout periods of prolonged storage to ensure proper performance.

Disposal of Your Power Scooter

Your power scooter must be disposed of according to applicable local and national statutory regulations. Contact your local waste disposal agency or authorized dealer for information on proper disposal of power scooter packaging, metal frame components, plastic components, electronics, batteries, neoprene, silicone, and polyurethane materials.

CHECKS:

- Make sure to keep the controller clean while protecting it from rain or water. Never hose off your power scooter or place it in direct contact with water.
- Keep wheels free from lint, hair, sand and carpet fibers.
- Visually inspect the tire tread. If less than 1mm (1/32”), please have your tires replaced by your local dealer.
- All upholstery can be washed with warm water and mild soap. Occasionally check the seat and back for sagging, cuts and tears. Replace if necessary. Do not store your scooter in damp or humid conditions as this will lead to mildew and rapid deterioration of the upholstery parts.
- All moving mechanism will benefit from simple lubrication and inspection. Lubricate using petroleum jelly or light oil. Do not use too much oil, otherwise small drips could stain and damage carpets and furnishings etc. Always perform a general inspection of the tightness of all nuts and bolts.

Cleaning and Disinfection

- Use a damp cloth and mild, non-abrasive cleanser to clean the plastic and metal parts of your power scooter. Avoid using products that may scratch the surface of your power scooter.
- If necessary, clean your product with an approved disinfectant. Make sure the disinfectant is safe for use on your product before application. Follow all safety instructions for the proper use of the disinfectant and/or cleaning agent before applying it to your product. Failure to comply may result in skin irritation or premature deterioration of upholstery and/or power scooter finishes.

CIRCUIT DIAGRAM

HW-05-02A

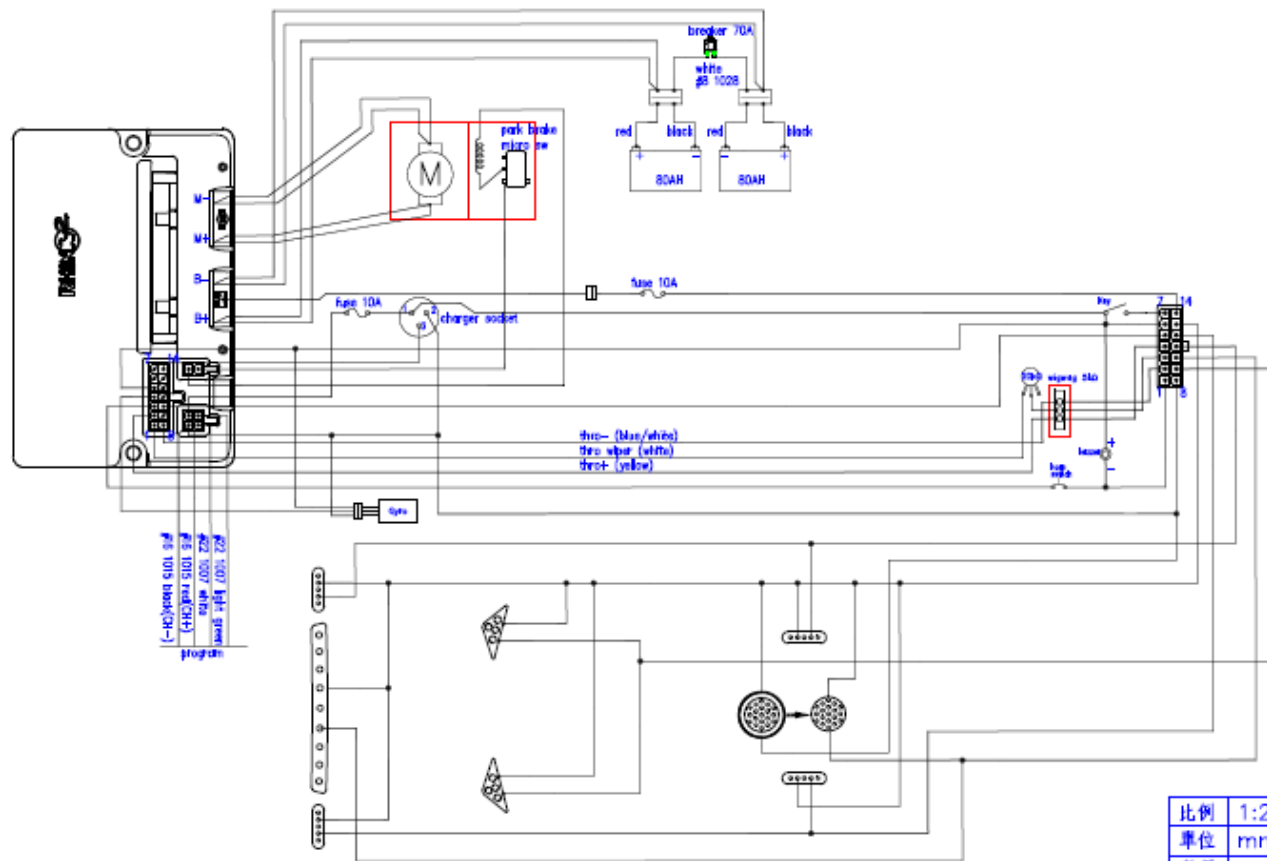

比例	1:2.6	確認	
單位	mm	核定	
數量		製圖	李茂裝
材質		日期	2016/09/14
		版次	0

△						品號	P:採購	M:自製	一般加工公差	區段	公差	機型			
△						屬性	S:託外加工			1-20	±0.2	名稱	WIRE DIAGRAM		
△						表面	無	電著		21-65	±0.4	圖號	S230E901	料號	
△						處理	CP	烤漆		66-260	±0.7	 台灣維順工業股份有限公司 HEARTWAY MEDICAL PRODUCTS CO., LTD.			
號碼	變更內容	日期	確認	核定	修正	鍍鉍	其他		260-980	±1.0					

BOM LIST

- | | | |
|------------------------|---------------------------|--------------------------|
| 1 TILLER FF COVER | 17 USB CHARGING BASE | 33 BATTERY UPPER SHROUD |
| 2 INDICATOR LIGHT | 18 PHONE BOX | 34 REAR COVER |
| 3 WIGWAG | 19 FRONT BUMBER | 35 CONTROLLER |
| 4 CONTROL PANEL ASM | 20 TILLER FR COVER | 36 TRANSAXLE |
| 5 REAR VIEW MIRROR | 21 TURNING MECHANISM L/R | 37 MAIN FRAME |
| 6 TILLER FRAME | 22 CAPTAIN SEAT ASM | 38 TAP PIPE WELDING L/R |
| 7 FOLD BRACKET SET | 23 SIDELIGHTS ESSENCE L/R | 39 OUTER RIM |
| 8 TILLER RAM MECHANISM | 24 SIDE LIGHT L/R | 40 WHEEL CAP |
| 9 SEAT SLIDING RAIL | 25 BRACKET FOR SIDELIGHT | 41 REAR BUMPER COVER |
| 10 SEAT BRACKET ASM | 26 FRONT SUSPENSION | 42 REAR LIGHT |
| 11 SEAT POST | 27 STEM ASM | 43 BRACKET FOR REARLIGHT |
| 12 HANDEL GRIP | 28 COUPLING BOLT ASM | 44 REAR SUSPENSION |
| 13 RUBBER DUST COVER | 29 WELDING BAR ASSY L/R | 45 REAR INNER RIM |
| 14 FLOOR | 30 FRONT INNER RIM | 46 TRANSAXLE FRAME |
| 15 FF COVER | 31 FRONT WHEEL | 47 BATTERY |
| 16 HEAD LIGHT | 32 CARPET | 48 INDICATOR LIGHT |

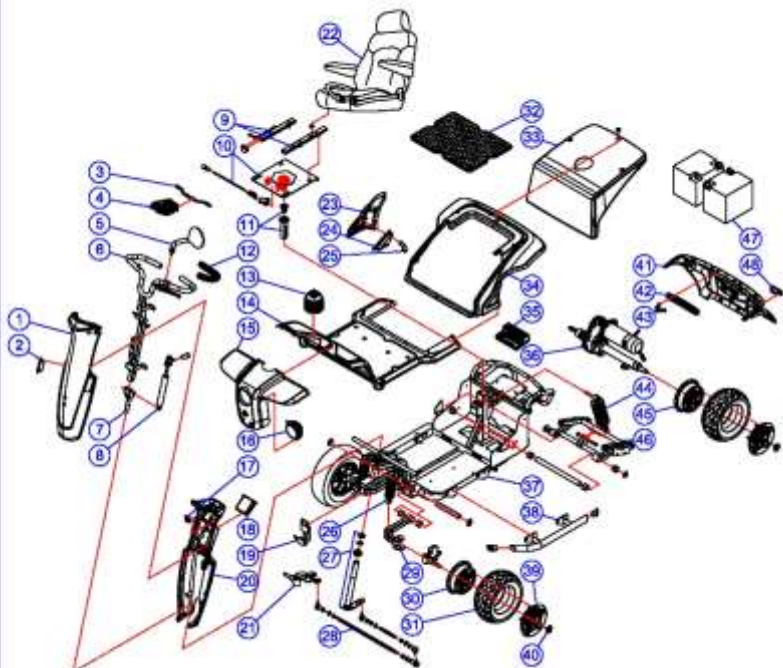

DEALER SERVICE INFORMATION-TROUBLE SHOOTING & FAULT REPAIR

RHINO controller: Your scooter is fitted with a Rhino controller, which continuously monitors the operating conditions of your scooter. If it detects a problem, it will indicate with error message by flashing light on the power ON/ OFF light. You must count the number of the flash, and see the list to check what kind of error has happened according to the number)

1	Battery Low	The batteries are running low or are in an over-discharged state. <ul style="list-style-type: none"> • Recharge the batteries.
2	Low Battery Fault	The batteries have run out of charge. <ul style="list-style-type: none"> • Recharge the batteries. • Check the battery and associated connections and wiring.
3	High Battery Fault	Battery voltage is too high. This may occur if overcharged &/or travelling down a long slope. <ul style="list-style-type: none"> • If travelling down a slope, reduce your speed to minimise the amount of regenerative charging.
4	Current Limit Time-out or Controller too hot	The motor has been exceeding its maximum current rating for too long. <ul style="list-style-type: none"> • The scooter may have stalled. Turn the controller off, leave for a few minutes and turn back on again. • The motor may be faulty. Check the motor and associated connections and wiring.
5	Park Brake Fault	Either a park brake release switch is active or the park brake is faulty. <ul style="list-style-type: none"> • Check the park brake and associated connections and wiring. • Ensure any associated switches are in their correct positions.

6	Drive Inhibit	Either a Stop function is active or a Charger Inhibit or OONAPU condition has occurred. <ul style="list-style-type: none"> • Release the Stop condition (seat raised etc.) • Disconnect the Battery Charger • Ensure the throttle is in neutral when turning the controller on. • The Throttle may require re-calibration.
7	Speed Pot Fault	The throttle, speed limit pot, SRW or their associated wiring may be faulty. <ul style="list-style-type: none"> • Check the throttle and speed pot and associated connections and wiring.
8	Motor Voltage Fault	The motor or its associated wiring is faulty. <ul style="list-style-type: none"> • Check the motor and associated connections and wiring.
9	Other error	The controller may have an internal fault. <ul style="list-style-type: none"> • Check all connections and wiring.

Note:
 If you experience any technical problems, it is recommended that you check with your local dealer before attempting to troubleshoot on your own. The following symptoms could indicate a serious problem with your power scooter. Contact your local dealer if any of the following arises:

Motor noise /Frayed harnesses / Cracked or broken connectors/ Uneven wear on any of tires/ Jerky motion
 Pulling to one side/ Bent or broken wheel assemblies/ Does not power up/ Powers up, but does not move

WARRANTY DECLARATION

Quality/ Warranty Declaration

Heartway will provide warranty parts, according to Heartway warranty replacement policy, to the importers/distributors/dealers, if the damaged/defective parts are found or reported during the warranty coverage period. However, the warranty coverage does not cover/apply to normal wear and tear or damage due to accident, abuse, misuse, modification, water, pets, children, improper storage or acts of God. The warranty becomes effective on the date of Purchase.

Heartway's Warranty as Following:

Frame: Three-year limited warranty

Controllers: One-year limited warranty

Electronic Components and Charger: One-year limited warranty

Warranty Exclusion. The following items are not covered by warranty.

Motor brushes	Wheel Tires	Arm Pads
Seat Cushion	Fuses / Bulbs	Ttiller Cover
Rear Shroud	Front Shroud	Batteries and Consumable parts

Any damage or defect of any nature occurring from the misuse, abuse of the product, improper operation or improper storage is not to be covered.

The warranty is to start from the date of arrival of our products.

Normally, the average lifespan of a scooter will last 5-year long.

Heartway will be able to provide the spare-part support for five-year long after scooters

purchased. Note: If you encounter a damaged or cracked battery; please enclose it in a plastic

bag and call the local authorized dealers immediately for instructions on disposal and recycling.