



Ultra Lightweight Family

Live without limits

Living an active life means putting your heart and soul into it, being part of something, taking a deep breath of nature, freeing your mind, and going beyond your limits. You need a chair you can rely on, that won't let you down. Quickie is the chair for those who won't compromise, who demand the ultimate in performance.



Ultra Lightweight Family

Table of Contents

Rigid Family		Page
Innovative	Quickie Q7	3
Core	Quickie GT	4
Value	Quickie GP Series	5
Folding Family		
Innovative	Quickie 2 Lite	6
Core	Quickie 2 Family	6
Value	Quickie QXi	7
Ultra Lightweight		
Coding & Justification		8
Complement Your Quickie – JAY® Cushions and Backs		8



Why Quickie?

You drive our design. Quickie wheelchairs are designed for you and by you. In development, we consider how you interact with your wheelchair to maintain maximum efficiency, performance, fit and style. This results in the creation of products that are innovative, durable, versatile and customizable. That is the Quickie Advantage.

Quickie Advantage

Innovation. We are continually developing new products, improving our flagship products and offering new options and solutions to enhance your lifestyle.

Quality and Durability. Quickie wheelchairs undergo rigorous testing that surpasses industry standards, so you can be confident that your product will hold up and perform throughout its lifetime.

Versatility. We offer a comprehensive portfolio of products to meet a wide range of individual lifestyles and clinical needs. Once you choose a Quickie, our goal is that it continues to be the right chair for you. We offer maximum adjustability in our designs, interchangeable parts and the True Fit Growth Program* to help accommodate changes in condition, environment or lifestyle that you may experience.

Built-4-Me. Our Built-4-Me Team is dedicated to creating product customizations beyond what is listed on our product order forms. Experts in the engineering and manufacturing of custom rehab products will listen to your specific requests and build a chair as individual as your fingerprint!

**Available on select Quickie wheelchairs*

Quickie Q7™

The Quickie Q7 is lighter than titanium and offers better performance and a sleek style at an aluminum price.



Unbelievably Lightweight

- Fully loaded configuration weighs as low as 12.75 lbs!
- 7000 Series Aluminum
 - Lightweight aluminum that can be tempered for strength through ShapeLoc Technology



ShapeLoc Technology is the process of converting an aluminum frame into stronger, more rigid T6 Aluminum. The open frame is fabricated using 7000 Series Aluminum then heat treated to convert the metal to T6 Aluminum.

The Advantage: Stronger metal + thinner tube walls = an unbelievably lightweight chair!

Unparalleled Performance

- New caster wheel placement options make the chair easier to turn
- Ovalized tubing in frame, axle plate and caster housing decreases frame flex
- Increased frame bend strength results in better propulsion efficiency

Unique Style

- Hydroformed caster housing design
- Color options
 - Wide variety of standard and Kolorfusion™ frame colors including Glow in the Dark, Titanium, Zebra, and Camo Patterns
 - Backrest frame and side guards can be ordered to match

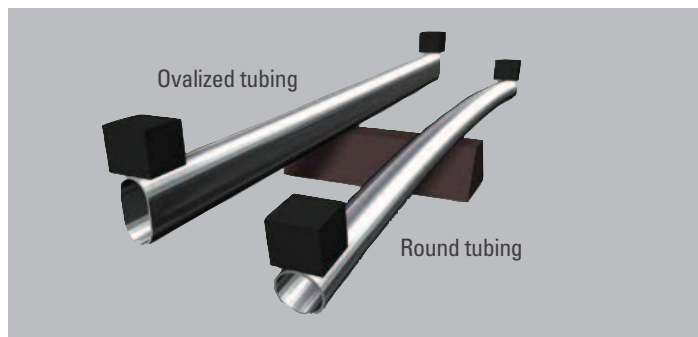

SPECIFICATIONS	Q7 Adjustable	Q7 Active Rigid
HCPCS Code	K0005	K0009
Frame Style	Rigid - Open	Rigid - Open
Transport Weight		
Lowest Possible Weight	14 lbs.	13 lbs.
Weight Capacity	265 lbs.	265 lbs.
Seat Widths	12" to 20"	12" to 20"
Seat Depths	12" to 20"	12" to 20"
Back Angle Adjustment	-27° to 8°	Fixed
Front STFH	16" to 21"	16" to 21"
Rear STFH	13" to 20"	13" to 20"
Frame Angles	75°, 80°, 85°	75°, 80°, 85°

RIGID

Quickie GT™

Combining performance and durability, the Quickie GT is extremely adjustable, offers multiple modifications and is parts-compatible with the Quickie manual family.

Versatile Performance

- Overall standard weight of 21.3 lbs.
- Mono frame design for easier propulsion, transportability and reduced risk of Repetitive Strain Injury
- Lite Spoke wheels are a standard option
- Performance Frame option has a shorter footprint for improved turning response and maneuverability

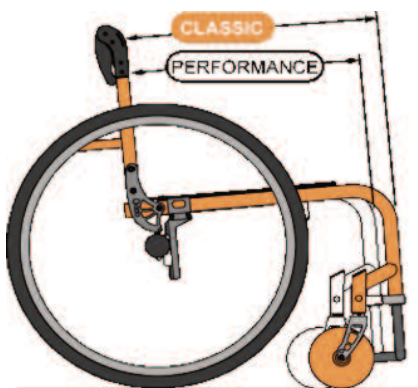

Adjustability

- Classic or Performance Frame options
- Folding Lockdown Angle Adjustable Backrest
- 3D Perpendicular caster alignment
- Axle Plate adjustment
- Depth Adjustable Back option

Folding Lockdown Angle Adjustable Backrest



Lifestyle Options

- Optional XTR Suspension
- Optional Quickie Xtender™ power assist wheels
- Over 20 frame colors
- Anodized parts
- Back-release lanyard
- Natural Fit™ Handrims



XTR Suspension



Anodized caster forks

SPECIFICATIONS	GT
HCPCS Code	K0005
Frame Style	Rigid - Open
Transport Weight	12.4 lbs.
Overall Weight	21.3 lbs.
Weight Capacity	265 lbs.
Seat Widths	12" to 20"
Seat Depths	12" to 22"
Back Angle Adjustment	-17° to 8°
Front STFH	16" to 21"
Rear STFH	13" to 20"
Frame Angles	75°, 80°, 85°

RIGID

Quickie GP™ Series

Maximizing function and minimizing rider effort, the Quickie GP is a user favorite, whether it's a first, everyday or competition chair.

Proven Performance

- One-piece welded frame for a lightweight, rigid ride
- Custom frame options for optimum positioning
- Adjustable axle plate with multiple positions
- Angle adjustable folding or fixed backrests
- Optional Quickie Xtender power assist wheels
- Optional Quickie Performance wheels for tennis and basketball



GPV

- Tapered, "V"-style front end for exceptional maneuverability
- Camber adjustable between 0° – 12° for easier propulsion



Quickie GP



GP SWING-AWAY

- Multiple hanger options to meet individual positioning needs
- Large variety of armrests for optimal upper body positioning and tray mounting

SPECIFICATIONS	GP	GPV	GPVA
HCPCS Code	K0005	K0005	K0005
Frame Style	Rigid - Traditional	Rigid - Traditional	Rigid - Traditional
Transport Weight	14 lbs.	9.7 lbs.	12.7 lbs.
Overall Weight	26 lbs.	21.5 lbs.	24.5 lbs.
Weight Capacity	250 lbs.	250 lbs.	250 lbs.
Seat Widths	12" to 22"	12" to 22"	12" to 20"
Seat Depths	12" to 22"	12" to 22"	12" to 22"
Back Angle Adjustment	-4° to 8°	-4° to 8°	-4° to 8°
Front STFH	15.5" to 23"	15.5" to 23"	16.5" to 20.5"
Rear STFH	14.5" to 20.5"	14.5" to 20.5"	16" to 20.5"
Frame Angles	60°, 70°, 75°, 80°	60°, 70°, 75°, 80°	Swing-Away

RIGID

Quickie 2™ Family

QUICKIE 2

Versatile, modular, and available in 64,000 configurations, the Quickie 2 has been the industry's favorite manual chair for over 25 years.

Modularity

- Multiple front frames and seat rails
- Independent cross brace and rear frame
- Allows for changes in user's condition, function, growth, and/or environment

Option Mix

- Multiple caster, rear wheel, armrest, tire and handrim options
- Depth adjustable and angle adjustable backs

Q-Fit™ Technology

- Tight fit between components for reduced noise in armrests and side guards
- Rigidity and performance for the life of the product



Quickie 2

QUICKIE 2 LITE

The Quickie 2 Lite is everything you love about the Quickie 2 in a simple and ultra lightweight package.

- Overall standard weight as low as 25.5 lbs.
- Simplified option mix
- Fixed front frame option for rigid performance in a folding frame
- Smooth, contoured and stylish
 - Rounded rear frame
 - Reduced side profile
 - Q-Gusset



Rounded rear frame and Q-Gusset



Quickie 2 Lite

SPECIFICATIONS	Quickie 2	Quickie 2 Lite
HCPCS Code	K0005	K0005
Frame Style	Folding - Traditional	Folding - Open
Transport Weight	17.6 lbs	17.1 lbs. (fixed front) 19.5 lbs. (swing away)
Overall Weight	29 lbs.	25.5 lbs. (fixed front) 27.8 lbs. (swing away)
Weight Capacity	265 lbs. (Standard) 350 lbs (Heavy Duty)	265 lbs.
Seat Widths	12" to 22"	14" to 20"
Seat Depths	12" to 22"	14" to 20"
Back Angle Adjustment	-15° to 3°	-14° to 4°
Front STFH	15"	14.5" to 21"
Rear STFH	13.5"	13" to 19.5"
Frame Angles	Swing-Away	70°, 80°, Swing-Away

FOLDING

Quickie QXi™

The Quickie QXi is a durable, ultra-lightweight folding wheelchair featuring quick and intuitive adjustments at an outstanding value.

Quick and Intuitive Adjustments

- Most adjustments can be made in less than one minute, using only one tool
 - Center of Gravity (Axle Plate)
 - Axle Spacing
 - Seat to Floor Height
 - Back Height
 - Camber

Simple Option Mix

- Options include the most frequently used armrests, wheels, tires, and seat widths and depths
- New Swing-in/Swing-out Hangers with simple footrest adjustments and intuitive release levers
- New Low Profile Dual Post Armrests
- Transit option

Smart Option Mix

- Ultra lightweight and durable aluminum frame with a 265 lb. weight capacity
- Three arm cross brace that sits inside frame for a more rigid ride

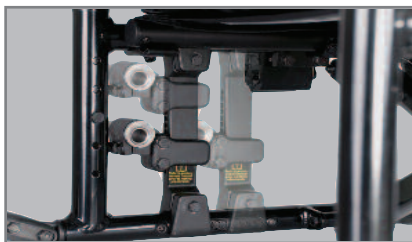

Adjustable Axle Plate



SPECIFICATIONS	QXI
HCPCS Code	K0005
Frame Style	Folding - Traditional
Transport Weight	17.6 lbs
Overall Weight	28.8 lbs.
Weight Capacity	265 lbs.
Seat Widths	14" to 20"
Seat Depths	14" to 20"
Back Angle Adjustment	-15° to 3°
Front STFH	12.5" to 19.5"
Rear STFH	12" to 19"
Frame Angles	Swing-Away

FOLDING

Ultra Lightweight Wheelchair Justification

K0005

- Per Medicare policy, "coverage of an ultra-lightweight wheelchair (K0005) is determined on an individual consideration basis." The primary objective is to rule out all lower level equipment.
- Include a list of indoor and outdoor Activities of Daily Living (ADLs) and document what specific features the wheelchair base has that are medically needed by the end user.
- Although not required, a seating evaluation conducted by a clinician experienced in seating & positioning is strongly recommended.

- Documentation "must include a description of the patient's routine activities. This may include the types of activities the patient frequently encounters and whether the patient is fully independent in the use of the wheelchair. Describe the features of the K0005 base which are needed compared to the K0004 base."

K0009

- Medicare does not have a stated medical policy for the K0009 code, therefore if billed, it must be clinically documented as to why a lower level wheelchair cannot meet their medical needs within the home.

JAY Seating Selection

JAY CUSHIONS

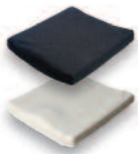

Basic
E2601, E2602

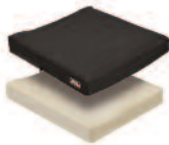

GO™
E2603, E2604



Soft Combi™ P
E2605, E2606

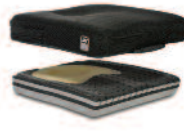

Lite
E2603, E2604,
E2607, E2608



Easy™
E2607, E2608



Ion™
E2607, E2608



Union™
E2607, E2608



J2™
E2622, E2623,
E2624, E2625



J2™ Deep Contour
E2622, E2623,
E2624, E2625

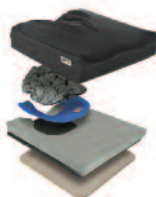

J3™
E2622, E2623
E2624, E2625



Zip™
E2607

JAY BACKS



Basic
E2611



GO™
E2611, E2612



Care™
E2615



J2™
E2613



J2™ Deep Contour
E2620



Focus Point™
E2620



J3™ Posterior
E2613



**J3™ Posterior
(over 22" wide)**
E2614



**J3™ Posterior
& Lateral**
E2615



**J3™ Posterior
Deep**
E2620

To learn more about customizing JAY seating products, visit the JAY Your Way product page on www.sunrisemedical.com.